

EMPIRE

COMFORT SYSTEMS

Model: FRBTPS

INSTALLATION AND OPERATION INSTRUCTIONS

IF YOU CANNOT READ OR UNDERSTAND THESE INSTALLATION INSTRUCTIONS DO NOT ATTEMPT TO INSTALL OR OPERATE

INTRODUCTION

This remote control system was developed to provide a safe, reliable, and user-friendly remote control system for gas heating appliances. The system can be operated thermostatically, manually or with the built-in factory program inside the transmitter. The built-in program has two segments, a weekdays and a weekend segment. The factory presets are time periods for each day. SEE PROGRAM SEQUENCE BELOW. Custom programming may be achieved after the initial setup has been performed.

This system operates on radio frequencies (RF) within a 20-foot range using non-directional signals. The system operates one of 1,048,576 security codes that are programmed into the transmitter at the factory; the remote receiver's code must be matched to that of the transmitter prior to initial use.

Built-in Factory Programs

Weekdays - Mon. Tues. Wed. Thurs. Fri.

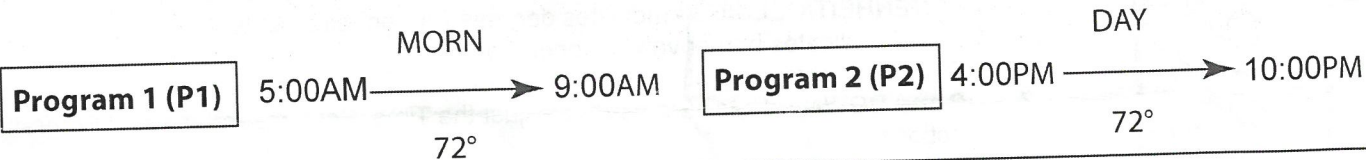

Weekends - Sat. Sun.

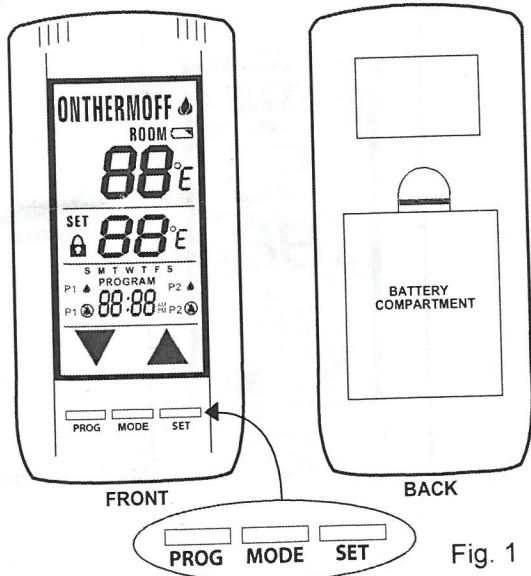
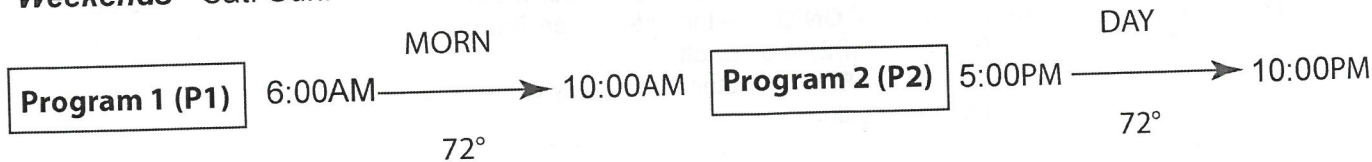

TRANSMITTER

The transmitter operates on (4) AAA 1.5V batteries that are included. Install the batteries supplied with the unit into the battery compartment. It is recommended that ALKALINE batteries always be used for this product. **Be sure the batteries are installed with the (+) and (-) ends facing the correct direction.**

When you start up the remote, if a low battery signal appears or if they LCD screen does not illuminate when you touch it, check battery position and if the batteries are fully charged.

KEY AND TOUCHSCREEN SETTINGS

1. **MODE** - Switches the appliance On/Thermo/Off.
2. **PROGRAM** - Turns ON and OFF the program function.
3. **SET** - Used in different functions to confirm settings.
4. **UP** and **DOWN** - Used to change the time, set temp, and programming functions.

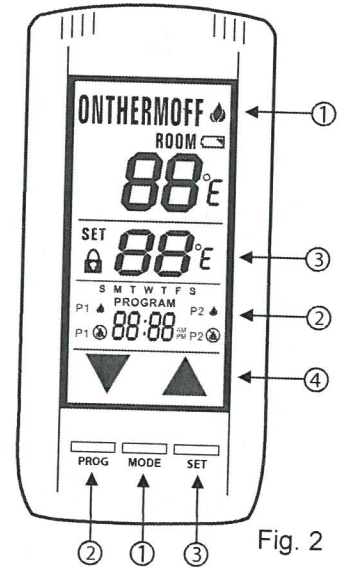

Fig. 2

LCD - LIQUID COLOR DISPLAY

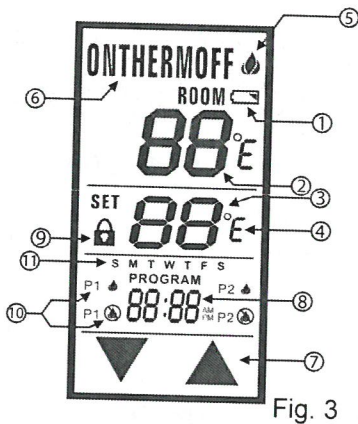

Fig. 3

1. **BATTERY ICON** - Battery power is low. Replace Batteries in 2 - 4 weeks.
2. **ROOM** - Indicates CURRENT room temperature.
3. **SET** - Indicates desired SET room temperature for THERMO operation.
4. **FAHRENHEIT/CELSIUS** - Indicates degrees Fahrenheit or Celsius.
5. **FLAME** - Indicates burner/valve in operation.
6. **MODE** - Indicates operation mode of system.
7. **UP and DOWN** - These are used to adjust the Time, Set temperature, and Program functions.
8. **TIME and PROGRAM TIME** - Indicates current time or program time setting when editing program settings.
9. **LOCK ICON** - Disables the transmitter when lock is visible on the LCD screen.
10. **PROGRAM ON/OFF** - Indicates when Program 1 (P1) is on or off, and indicates when Program 2 (P2) is on or off.
11. **DAY of WEEK** - Indicates current day of week, or program segment when editing program settings.

BASIC TRANSMITTER FUNCTIONS AND INITIAL SETUP

NOTE: Touch anyplace on the screen and the back light will light up and stay lit for 5 seconds.

MODE FUNCTION

To select an operational mode, press the **MODE** button or touch the **MODE SECTION** of the touch screen.

- **ON** turns the appliance manually ON; the flame icon will appear.
- **THERMO** sets the remote to Thermostatic mode.
- **OFF** turns the appliance OFF; the flame icon will disappear.

SETTING °F / °C SCALE

The factory setting for temperature is °F. To change this setting to °C, first press and hold the **UP** touch button and the **DOWN** touch button on the transmitter at the same time. Follow this same procedure to change from °C back to °F.

NOTE: When changing between the °F and °C scales, the set temperature defaults to the lowest temperature (45 °F, or 6 °C).

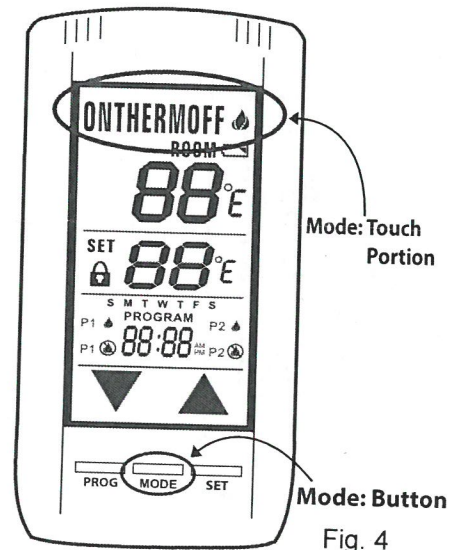

Fig. 4

SETTING THE CLOCK

- Press and hold the **SET** button, or touch the SET section on the touch screen, for 5 seconds. The hour section should begin to flash. (FIG. 5)
- Use the **UP** and **DOWN** touch buttons to select the hour, then press **SET**.
- The minutes will be flashing. Use the **UP** and **DOWN** touch buttons to select the minute, then press **SET**. (FIG. 6)
- The AM PM will be flashing. Use the **UP** and **DOWN** touch buttons to select one of them, then press **SET**. (FIG. 7)
- One of the days of the week will be flashing (above the clock). Select the correct day by pressing the **UP** and **DOWN** touch buttons, then press **SET**. Your time will automatically be accepted. (FIG. 8)

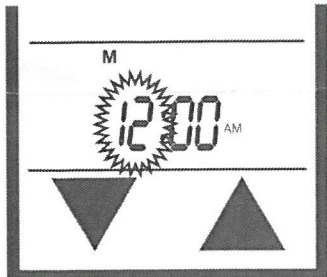

Fig. 5

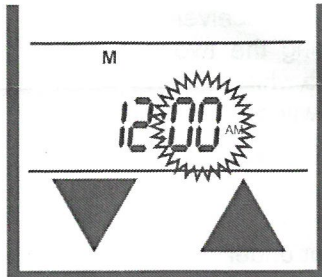

Fig. 6

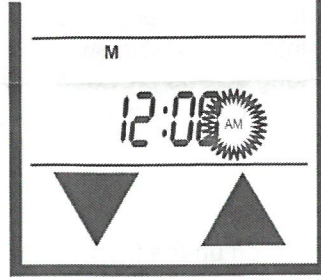

Fig. 7

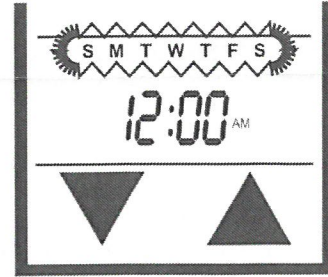

Fig. 8

WARNING

This remote control system must be installed exactly as outlined in these instructions. Read all instructions completely before attempting installation. Follow instructions carefully during installation. Any modifications of this remote control or any of its components will void the warranty and may pose a fire hazard.

Do not connect any gas valve or electronic module directly to 110-120VAC power. Consult gas appliance manufacturer's instructions and wiring schematics for proper placement of all wires. All electronic modules are to be wired to manufacturer's specifications.

The following wiring diagrams are for illustration purpose only. Follow instructions from manufacturer of gas valve and/or electronic module for correct wiring procedures. Improper installation of electric components can cause damage to electronic module, gas valve and remote receiver.

INSTALLATION

The remote receiver can be either wall-mounted in a standard plastic switch box (not metal) or placed on or near the fireplace hearth. Preferably, the remote receiver should be wall-mounted in a plastic switch box, as this will protect its electronic components from the heat produced by the gas appliance. The remote receiver should be kept away from temperatures exceeding 130° F. Battery life is also significantly shortened if batteries are exposed to temperatures 130° F or higher.

Before installation make sure the remote receiver slide switch is in the **OFF** position. After installation be sure that the slide switch is moved to the **REMOTE** position.

MOUNTING THE REMOTE RECEIVER

WALL MOUNT

When wall mounting the remote receiver, longer wires (not included) are required to connect to the gas valve or electronic module. These wires must:

- Be at least 18-gage (AWG)
- Be no longer than 20-feet
- Have no splices

To attach Cover Plate to Receiver Box:

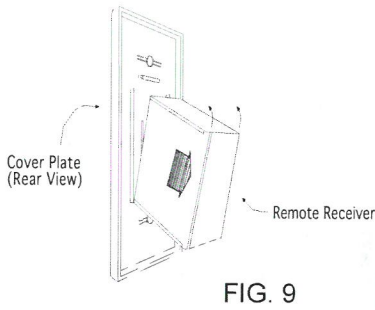

FIG. 9

Position the receiver as shown in diagram to the left with lower tab on cover plate inserted into groove of receiver (Make sure LEARN hole on cover plate properly aligns with remote receiver). Pull receiver up and snap into top tab of cover plate.

Position the cover plate so the word ON is facing up; then, install the remote receiver into the plastic switch-box using the two long screws provided. Push the white button over the receiver slide switch.

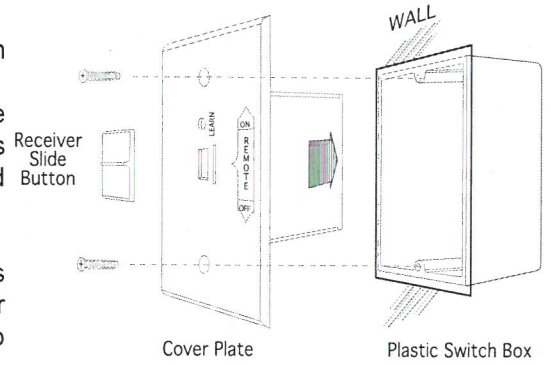

FIG. 10

HEARTH MOUNT

- The remote receiver can be placed on the fireplace hearth or under the fireplace behind the control access panel.
- Use the wires attached to the remote receiver to connect to the gas valve or the electric module (piggyback connectors have both male & female terminals for flexibility).
- Be sure that the connectors do not touch each other or other bare metal surfaces; this will cause the appliance to turn ON. The connectors may be wrapped with electrical tape to prevent this.

WIRING INSTRUCTIONS

A qualified electrician should install the remote control system.

WIRING MILLIVOLT VALVES

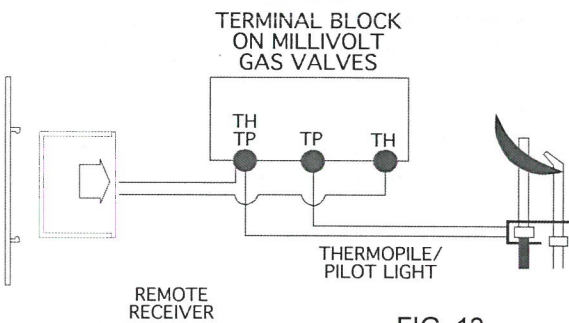

FIG. 12

- Connect one wire from the remote receiver to the TH terminal on the gas valve.
- Connect the other wire from the remote receiver to the TH/TP terminal on the gas valve.

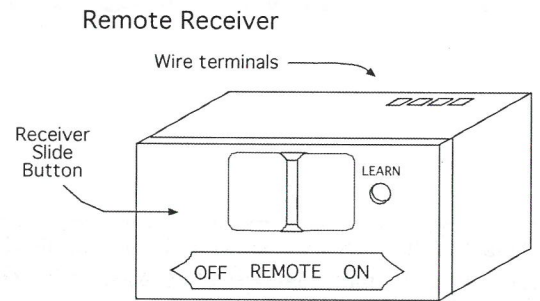

FIG. 11

MILLIVOLT SYSTEM CHECK

- Ensure that the pilot flame is lit.
- Slide the 3-position button on the remote receiver to the **ON** position. The main gas flame (i.e., the fire) should ignite.
- Slide the button to **OFF**. The main flame should extinguish (the pilot flame will remain ON).
- Slide the button to **REMOTE**, then press the **ON** button on the transmitter to change the system to ON. The main gas flame should ignite.

WIRING ELECTRONIC SPARK IGNITIONS

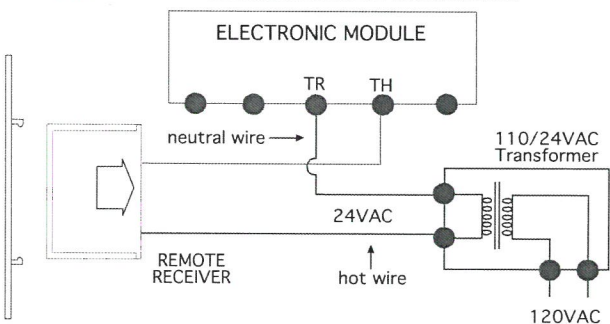

FIG. 13

The remote control receiver can be connected, in series, to a 24VAC transformer to the TR (transformer) terminal on the ELECTRONIC MODULE. Connect the hot wire from the 24VAC transformer to either of the wire terminals on the remote receiver. Connect another wire between the other receiver wire terminal and the TH (thermostat) terminal on the ELECTRONIC MODULE.

ELECTRONIC SPARK SYSTEM CHECK

- Slide the 3-position button on the remote receiver to the **ON** position. The spark electrode should begin sparking to ignite the pilot. After the pilot flame is lit, the main gas valve should open and the main gas flame should ignite.
- Slide the button to **OFF**. The main gas flame and pilot flame should both extinguish.
- Slide the button to **REMOTE**, then press the **ON** button on the transmitter to change the system to ON. The spark electrode should begin sparking to ignite the pilot. After the pilot is lit, the main gas valve should open and the main gas flame should ignite.

RECEIVER

Install the (4) AA-size batteries supplied with the unit. It is recommended that ALKALINE batteries always be used for this product. **Be sure the batteries are installed with the (+) and (-) ends facing the correct direction.**

The remote receiver has a 3-position slide switch for selecting the mode of operation **ON/REMOTE/OFF**

- **ON**: will manually turn ON the appliance.
- **REMOTE**: will allow use of handheld transmitter. If the system does not respond to the transmitter on initial use, check the battery positions in the remote. If that does not work, see **LEARNING TRANSMITTER TO RECEIVER** section.
- **OFF**: will disable the remote receiver.
- **It is suggested that the slide switch be placed in the OFF position if you will be away from your home for an extended period of time.**

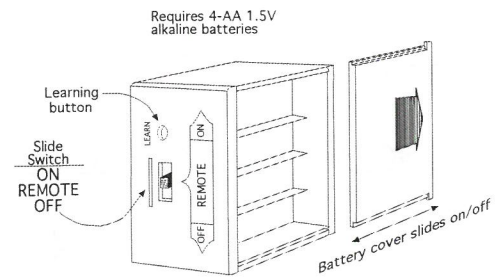

FIG. 14

LEARNING TRANSMITTER TO RECEIVER

Each transmitter uses a unique security code. It will be necessary to press the LEARN button on the receiver to accept the transmitter security code upon initial use, if batteries are replaced, or if a replacement transmitter is purchased from your dealer or the factory. In order for the receiver to accept the transmitter security code, be sure the slide button on the receiver is in the REMOTE position; the receiver will not LEARN if the slide switch is in the ON or OFF position. The LEARN button is located on the front face of the receiver; inside the small hole labeled LEARN. Using a small screwdriver or end of a paperclip gently Press and Release the black LEARN button inside the hole. When you release the LEARN button the receiver will emit an audible "beep". After the receiver emits the beep press the transmitter MODE button and release. The receiver will emit several beeps indicating that the transmitter's code has been accepted into the receiver.

THERMOSTAT FUNCTION

This remote control system can be thermostatically controlled when the transmitter is in the THERMO mode (THERMO must be displayed on the screen). To set the desired room temperature, press the **MODE** button to place the transmitter into thermo mode, then press the **UP** or **DOWN** touch buttons to select the desired room temperature. The highest set temperature is 99° F (32° C).

NOTE: The thermo feature operates the appliance whenever the room temperature varies a certain number of degrees from the set temperature. This variation is called the "swing" or temperature differential. This feature lets the appliance turn off and on 2° F (1° C) above or below the set temperature of the room. This is to cushion the number of times the appliance is turned ON and OFF.

THERMO UPDATING FEATURE - TRANSMITTER

When in thermo mode, the transmitter reads the ROOM temperature every 2 minutes, checks the room temperature against the SET temperature then sends a signal to the receiver.

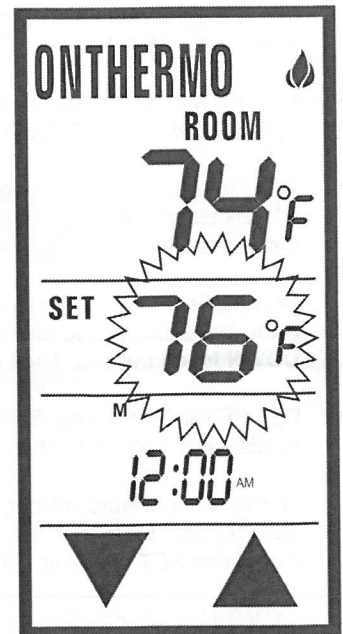

Fig. 15

PROGRAM FUNCTION

This remote has two default program segments (P1) and (P2): A weekday segment and a weekend segment. To enter program mode, push the **PROG** button or touch the **PROGRAM** portion of the touchscreen; the word PROGRAM will appear above the display time to indicate program operation is active.

The factory presets are:

WEEKENDS	WEEKDAYS
"P1 ON" 6:00 AM at 72°F	"P1 ON" 5:00 AM at 72°F
"P1 OFF" 10:00 AM	"P1 OFF" 9:00 AM
"P2 ON" 5:00 PM at 72°F	"P2 ON" 4:00 PM at 72°F
"P2 OFF" 10:00 PM	"P2 OFF" 10:00 PM

The user may override the program function by putting the remote in MANUAL ON mode. When the user turns the remote back to OFF mode, the remote will resume regular program mode (the word PROGRAM is above the display time, see figure #10). To turn the program function OFF, touch the **PROGRAM** portion on the touchscreen, or press the **PROG** Button at the bottom of the transmitter. The word PROGRAM will disappear from the LCD screen.

EDITING PROGRAM SETTINGS

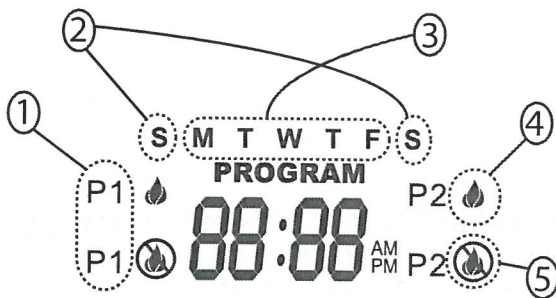

Fig. 16

- Program Segment:** (P1) Program 1 (left side of LCD screen), or (P2) Program 2 (right side of LCD screen).
- Weekend Segment:** Saturday and Sunday.
- Weekday Segment:** Monday through Friday.
- Flame ON:** Flame icon shows your appliance to turn ON.
- Flame OFF:** Flame icon shows your appliance to turn OFF.

**NOTE: P1 CAN ONLY BE SET FROM 12:00AM to 12:00PM
P2 CAN ONLY BE SET FROM 12:00PM to 12:00 AM**

To edit the program settings press either the **PROG** button or touch the Program section of the touch screen and hold for 5 seconds, the program section of the LCD screen will begin to flash.

- P1 ON and "S S" (Weekend Segment) should be flashing. Select the time you want your appliance to turn ON by using the **UP** and **DOWN** touch buttons. Then press **SET** (See Fig. 17).
- P1 OFF will be flashing. Select the time you want your appliance to turn OFF. Then press **SET** (See Fig. 18).
- The set temperature will begin to flash. Use the **UP** and **DOWN** touch buttons to select a temperature for P1, then press **SET** (See Fig. 19).
- Now the P2 ON will begin to flash. Select the time you want your appliance to turn ON by using the **UP** and **DOWN** touch buttons. Then press **SET**. (See Fig. 20).
- P2 OFF will be flashing. Select a time you want your appliance to turn OFF. Then press **SET** (See Fig. 21).
- The set temperature will begin to flash. Use the **UP** and **DOWN** touch buttons to select a temperature for P2, then press **SET** (See Fig. 19).
- "MTWTF" (Weekday Segment) will replace "S S". P1 ON will be flashing. Repeat the above steps to set the ON and OFF times and set temperatures for weekdays. (See Fig. 22)



Fig. 17



Fig. 18

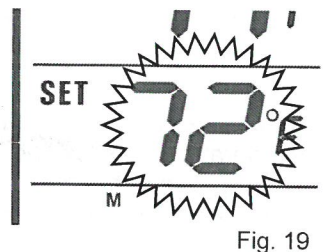

Fig. 19



Fig. 20



Fig. 21



Fig. 22

	Weekends (Sat. - Sun.)			Weekdays (Mon. - Fri.)		
Program	ON	OFF	TEMP	ON	OFF	TEMP
P1						
P2						

Blank table to record custom programming

SETTING THE TEMPERATURE SWING (TEMPERATURE DIFFERENTIAL)

The Thermo Mode on the transmitter operates the appliance whenever the room temperature varies a certain number of degrees from the set temperature. This variation is called the “**SWING**” or **TEMPERATURE DIFFERENTIAL**. The factory preset swing temperature is 2° F (1° C). To change the “Swing Setting:”

- Press the **SET** button and the **DOWN** touch button simultaneously to display the current “swing” setting in the set temp frame. The letter “S” will display in the room temp frame on the LCD screen.
- Press the **UP** or **DOWN** touch button to adjust the “SWING” temperature (1°- 3° F) (1°- 2° C).
- To store the “swing” setting press the **SET** button, and the new “swing” setting will be automatically programmed.

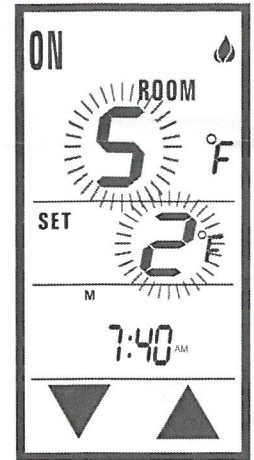

Fig. 23

COMMUNICATION - SAFETY (C/S - TX)

This remote control has a COMMUNICATION –SAFETY function built into its software. It provides an extra margin of safety when the Transmitter is out of the normal 20-foot operating range of the receiver.

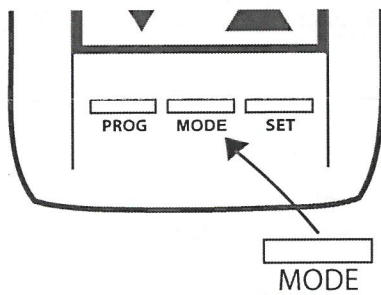

Fig. 24

At all times and in all OPERATING MODES, the transmitter sends an RF signal every 15 minutes, to the receiver, indicating that the transmitter is within the normal operating range of 20-feet. Should the receiver NOT receive a transmitter signal every 15 minutes, the receiver will begin a 2 hour (120 minute) countdown timing function. If during this 2-hour period, the receiver does not receive a signal from the transmitter, the receiver will shut down the appliance being controlled by the receiver. The receiver will then emit a series of rapid “beeps” for a period of 10 seconds. Then after 10 seconds of rapid beeping, the receiver will continue to emit a single “beep” every 4 seconds until a transmitter MODE button is pressed to reset the receiver.

CHILDPROOF “LOCK-OUT” - (CP)

This remote control includes a CHILDPROOF “LOCK-OUT” feature that allows the user to “LOCK-OUT” operation of the appliance from the TRANSMITTER.

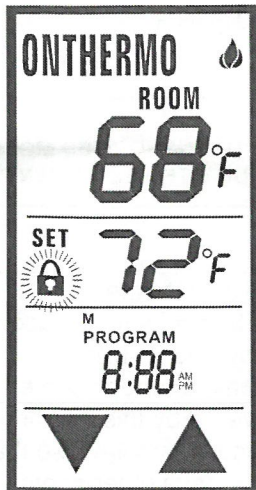

Fig. 25

- To activate the “LOCK-OUT” feature, press and hold the **UP** touch button and the **SET** button together for 5 seconds. The lock icon will appear on the LCD screen.
- To disengage the “LOCK-OUT”, press and hold the **UP** touch button and the **SET** button together for 5 seconds or more, the lock icon will disappear from the LCD screen and the transmitter will return to its normal operating condition.
- When the Transmitter is in “LOCK-OUT” mode, programmed functions will go on without interruption; Only manual functions are prevented.

WALL MOUNT

The transmitter can be placed on a wall using the mount provided.

- Wood - Drill 1/8" pilot holes and install with screws provided.
- Plaster/Wallboard - Drill 1/4" holes, use a hammer to tap in the two plastic anchors. Then install with the screws provided.

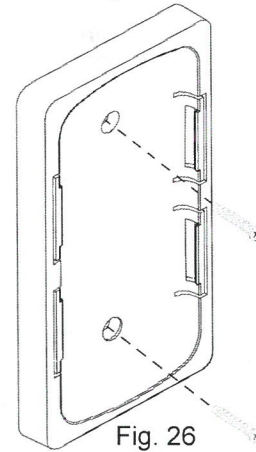

Fig. 26

BATTERY LIFE

Life expectancy of the alkaline batteries in the transmitter and receiver should be at least 12 months. Check and replace all batteries:

- Annually.
- When operating range becomes reduced.
- When transmissions are not received by the remote receiver.
- If the remote receiver batteries measure less than 5.3 volts (all (4) batteries in combination).
- If the hand held transmitter batteries measure less than 5.3 volts all (4) batteries in combination).

TROUBLE SHOOTING

If you encounter problems with your fireplace system, the problem may be with either the fireplace itself or with the remote. Review the fireplace manufacturer's operation manual to make sure all connections are properly made. Then check the operation of the remote in the following manner:

- Make sure all batteries are correctly installed in the transmitter and receiver. Also check that the batteries are fully charged.
- Check batteries in transmitter to ensure contacts are touching (+) and (-) ends of battery. Bend metal contacts in for tighter fit.
- Be sure receiver and transmitter is within 20 to 25-foot operating range.
- Keep receiver from temperatures exceeding 130° F. Battery life will be shortened if exposed to high temperatures.
- If receiver is installed in a tightly enclosed metal surrounding, the operating distance will be shortened.
- Make sure the hand-held transmitter and remote receiver are communicating properly (see LEARNING TRANSMITTER TO RECEIVER section).

FCC REQUIREMENTS

NOTE: THE MANUFACTURER IS NOT RESPONSIBLE FOR ANY RADIO OR TV INTERFERENCE CAUSED BY UNAUTHORIZED MODIFICATIONS TO THE EQUIPMENT. SUCH MODIFICATIONS COULD VOID THE USER'S AUTHORITY TO OPERATE THE EQUIPMENT

This REMOTE CONTROL SYSTEM is warranted for 12 months from the date of purchase or installation to the original purchaser to be free from defects in materials and workmanship. Damage to the SYSTEM caused by accident, misuse, abuse, or installation error whether performed by a contractor, service company, or owner, is not covered by this warranty. Seller will not be responsible for labor charges and/or damage incurred in installation, repair, and replacement or for incidental or consequential damages. Batteries and any damage caused by them are not covered by this warranty. Some states, provinces, and nations do not allow exclusion or limitations of incidental or consequential damages, so the above limitations or exclusions may not apply. This warranty gives you specific legal rights. You may have other rights that vary by state, province or nation.